

THE RHEOLOGICAL-DYNAMICAL HARMONIC OSCILLATOR*UDC 532.511(045)=111***Dragan D. Milašinović**

Faculty of Civil Engineering, Subotica, Serbia

Abstract. *In this paper the rheological-dynamical theory of the analytical dynamics of discrete visco-elasto-plastic system is presented. The rheological-dynamical analogy (RDA) has been developed on the basis of mathematical-physical analogy between the rheological model and the discrete dynamical model with viscous damping and is aimed to be used for the analysis of inelastic deforming of materials and structures. In this presentation, the coupled initial conditions of the stress-strain state of the rheological visco-elasto-plastic model are applied for the study of discrete dynamics system. Mechanical systems that have their masses and elastic forces distributed, such as cables, rods, beams, plates, etc., rather than lumped together in concentrated masses by springs belong to this class of vibrations of continuous media. These systems consist of an infinitely larger number of particles, and hence require an infinitely large number of coordinates to specify their configurations. These notes give an example illustrating how discrete model can be derived from special limits of the continuum model using the principle of analogy. This technique is useful because discrete model is often much easier to deal with than continuum model, both conceptually and computationally.*

Key words: *RDA analogy, RDA harmonic oscillator, viscous damping ratio*

1. INTRODUCTION

Any system, discrete or continuous, capable of vibrating must have mass and stiffness. Mass implies that once the system starts moving it will possess inertia which will make the system continue moving. On the other hand, stiffness implies that change in the configuration of the system due to some internal or external disturbance will be accompanied by a change in potential energy. However, such a system cannot show vibration characteristics until it is disturbed from the position of equilibrium. A vibrating system would be conservative if its potential energy is interchangeable with the kinetic energy so that over any cycle of operation (at the end of which the configuration of the system is the same as it was at the beginning) the work done is zero.

A non-conservative system implies gradual loss of total energy content with time through forces, which do not depend on a potential. Traditionally the energy dissipation in a system, caused by losses in the surrounding medium, feedback in the foundation soil, internal friction of the construction materials, hysteretic behavior of the members of the

system and the friction at the connections, is represented by an idealized viscous damping force, i.e. a force directly proportional to the velocity of the system. The external forces are generally induced by several factors such as the earthquake, wind, rotating machines and etc. When a linear analysis is used to predict the dynamic response of a structure, viscous damping is the only factor that takes account of the energy dissipation of the structure and it is well understood that the viscous damping coefficients are of major importance in the dynamic analysis. The structure mass and stiffness matrices remain constant during the analysis and they satisfy the well known orthogonality conditions, Clough and Penzien [1]. If the damping matrix also satisfies orthogonality, the incremental equations of motion for a discretised multi-degree-of-freedom structure can be decoupled into n independent equations, one for each normal mode of the structure. It is equivalent to assuming that the normal modes of the damped system are identical to those of the undamped system; this is basically true for low values of damping. It is obvious that if the damping matrix is a linear combination of orthogonal matrices, such as mass and stiffness matrices, it will satisfy orthogonality.

The strain induced in a purely elastic linear material is proportional to the stress that produces the deformation. When a linear visco-elastic material (hereditary medium) is subjected to time-dependent variations of stress and strain, the fundamental shear or volume deformation of the material is no longer related to stress by a simple constant of proportionality-the shear modulus or bulk modulus. Rather, the relation between stress and strain is most generally represented by a linear partial differential equation of arbitrary order. Mechanics of hereditary medium is presented in scientific literature by the array of monograph: Reiner [10] and Goroshko and Hedrih (Stevanović) [2].

Inelastic deforming of materials is based on the mathematical physical analogy between rheological model and dynamical model with viscous damping, the so-called RDA that was suggested in the monograph from Milašinović [4]. RDA modeling technique for material behavior of axially cyclically loaded rods has already been explained by Milašinović [5], where RDA was used to predict the buckling behavior of slender columns. In the second paper, Milašinović [6], the author demonstrates that RDA is also capable of modeling the fatigue behavior. The efficient numerical implementation of RDA and its practical application was also studied by Milašinović [7] in the visco-elasto-plastic behavior of metallic rods where the RDA loading function for Hencky's theory is derived.

The objective of the present paper is to explain the physical mechanism of viscous damping, which is based on analogy. In such an analysis, the structure is usually represented by a simple vibration model. Taking into account RDA, rheologic behavior of bar can only be characterized by a single parameter, i.e. the dynamic time of retardation $T_K^D = l / \omega$, or a characteristic time for which a wave at the velocity c takes to propagate a length of the bar l_0 . In the stage of visco-elasticity, the RDA model has the same phase angle as a simple single-degree-of-freedom spring mass system with damping in the steady state vibration and from that the viscous damping ratio is obtained.

2. THE DISCRETE VISCO-ELASTO-PLASTIC RDA SYSTEM

Many vibrating objects vibrate normally in a way that establishes standing waves in the object. A standing wave is formed, for instance, in a stretched flexible string when

one end is fixed and vibratory motion is imparted to other end. The points of a standing wave at which the amplitude is equal to zero are called its nodes; the points at which the amplitude reaches its maximum value are called antinodes. The distance between two adjacent nodes and between two adjacent antinodes are the same and equal to half the wave-length λ of the traveling waves. This distance is called the length of the standing wave: $\lambda_{st} = \lambda / 2$.

We shall now consider the bar of Fig. 1a) of length l_0 loaded by the axial force $P(t)$, which retains its magnitude and direction as the bar deflects. Suppose that length of the bar under compressive critical load at the point of elasticity E is equal to the length of the standing wave ($l_0 = \lambda_{st}$). In this way we obtained a physical significance for the characteristic length l_0 . Let A be the constant cross section area of the uniform bar where the lateral dimensions remains small in comparison with the wavelength. In this case the radial motion of the bar (Poisson's ratio effect) may be neglected and the bar may be regarded as "long" bar. The vibration of the bar of significant lateral dimensions is determined from a "corrected" theory given by Love [3].

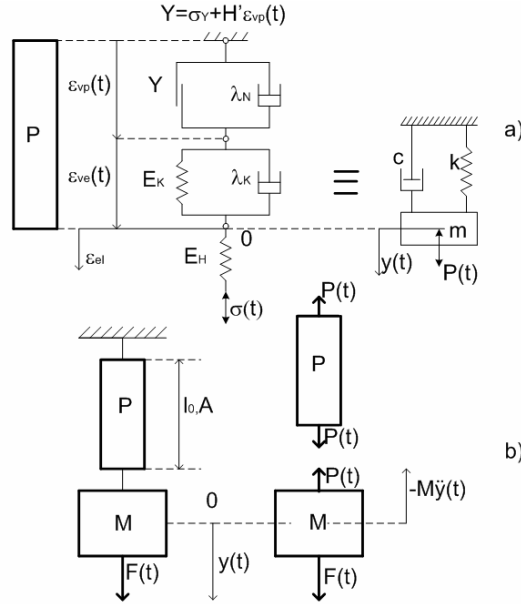

Fig. 1. Discrete visco-elasto-plastic RDA system

Let $y(x,t)$ be the longitudinal motion of the bar

$$y(x,t) = \varepsilon(t)x \tag{1}$$

The total strain $\varepsilon(t)$ is modeled according to the principle of RDA by Milašinović [5]

$$m \frac{d^2 \varepsilon}{dt^2} + c \frac{d \varepsilon}{dt} + k \varepsilon = \tilde{m} \frac{d^2 \sigma}{dt^2} + \tilde{c} \frac{d \sigma}{dt} + \tilde{k} \sigma - \tilde{k}^* \sigma_Y \tag{2}$$

where:

$$\begin{aligned}
 m &= \frac{\lambda_K \lambda_N}{\gamma} = k T_K^{D^2}, \quad c = \frac{E_K \lambda_N + H' \lambda_K}{\gamma} = 2k T_K^D \\
 \tilde{m} &= \frac{1}{E_H} k T_K^{D^2}, \quad \tilde{c} = \frac{1}{E_H} k (2 + \varphi_{vp}) T_K^D \\
 \tilde{k} &= \frac{1}{E_H} k (1 + \varphi_{vp}), \quad \tilde{k}^* = \frac{1}{E_H} k (\varphi_{vp} - \varphi^*) \\
 k &= \frac{E_H A}{l_0}
 \end{aligned} \tag{3}$$

$$\varphi_{vp} = \varphi^* (1 + i), i = 0, 1, 2, \dots$$

$$T_K^D = \frac{l_0}{\sqrt{\frac{E_H}{\rho}}}$$

i is the level for visco-plastic yielding at any stage of dynamic equilibrium. φ^* represents the visco-elastic creep coefficient of the material of the bar, see Milašinović [5]. T_K^D represents a characteristic time (the dynamic time of retardation) for which a wave at the velocity $c = \sqrt{E_H / \rho}$ takes to propagate the distance l_0 .

The total visco-elasto-plastic strain was solved theoretically on the harmonic excitation $\sigma(t) = \sigma_0 + \sigma_A \sin(\omega_\sigma t)$ by Milašinović [9]. The strain ε_h , under constant stress $\sigma_0 < \sigma_Y$, with initial conditions (4) is only visco-elastic strain

$$\varepsilon_0 = \varepsilon_{el} = \frac{\sigma_0}{E_H}, \quad \frac{d\varepsilon_0}{dt} = \sigma_0 \frac{\varphi^*}{E_H T_K^D} + (\sigma_0 - \sigma_Y) \frac{i\varphi^*}{E_H T_K^D} \tag{4}$$

$$\varepsilon_h = \frac{\sigma_0}{E_H} (1 + \varphi^*) \tag{5}$$

The cyclic visco-elasto-plastic steady strain is given by

$$\varepsilon_p = \varepsilon(t) = \frac{\sigma_A}{E_H} \sqrt{\frac{(1 + \varphi_{vp})^2 + \delta^2}{1 + \delta^2}} \sin\left(\omega_\sigma t - \arctan \frac{\delta \varphi_{vp}}{1 + \delta^2 + \varphi_{vp}}\right) \tag{6}$$

The constant and variable components of cycle are σ_0 and σ_A respectively, while σ_Y is the yield stress. δ represents the relative frequency of the RDA model, $\delta = \omega_\sigma / \omega$, where $\omega_\sigma = \omega_F$.

The RDA system (Fig. 1b) consists from a main mass M , which is periodically excited and its resonance amplitudes should be minimized by the influence of the material of the bar-like visco-elasto-plastic substance under cyclic strain. When gusts occur, the

cyclic stress causes cyclic visco-elasto-plastic strain to the substance, which then absorbs energy. The motion $y(l_0, t)$ of the damper P is described by the equation similar to Eq. 2

$$m \frac{A}{l_0} \frac{d^2 y}{dt^2} + c \frac{A}{l_0} \frac{dy}{dt} + k \frac{A}{l_0} y = \tilde{m} \frac{d^2 P}{dt^2} + \tilde{c} \frac{dP}{dt} + \tilde{k} P - \tilde{k}^* P_Y \quad (7)$$

where

$$y = y(l_0, t) = \varepsilon(t) l_0$$

$$P = P(t) = \sigma(t) A \quad (8)$$

According to the D'Alambert's principle, the following equation could be written for the dynamic equilibrium of forces acting on the RDA system

$$M \frac{d^2 y}{dt^2} + P(t) = F(t) \quad (9)$$

Thus

$$P(t) = F(t) - M \frac{d^2 y}{dt^2}, P_Y = F_Y - M \frac{d^2 y_Y}{dt^2}$$

$$\frac{dP}{dt} = \frac{dF}{dt} - M \frac{d^3 y}{dt^3} \quad (10)$$

$$\frac{d^2 P}{dt^2} = \frac{d^2 F}{dt^2} - M \frac{d^4 y}{dt^4}$$

The motion of the RDA system is described by the equation with the highest derivative of the fourth order with respect to time t

$$\begin{aligned} m \frac{A}{l_0} \frac{d^2 y}{dt^2} + c \frac{A}{l_0} \frac{dy}{dt} + k \frac{A}{l_0} y = \tilde{m} \left(\frac{d^2 F}{dt^2} - M \frac{d^4 y}{dt^4} \right) + \tilde{c} \left(\frac{dF}{dt} - M \frac{d^3 y}{dt^3} \right) + \\ + \tilde{k} \left(F - M \frac{d^2 y}{dt^2} \right) - \tilde{k}^* \left(F_Y - M \frac{d^2 y_Y}{dt^2} \right) \end{aligned} \quad (11)$$

or

$$\begin{aligned} \tilde{m} M \frac{d^4 y}{dt^4} + \tilde{c} M \frac{d^3 y}{dt^3} + \tilde{k} M \frac{d^2 y}{dt^2} - \tilde{k}^* M \frac{d^2 y_Y}{dt^2} + m \frac{A}{l_0} \frac{d^2 y}{dt^2} + c \frac{A}{l_0} \frac{dy}{dt} + k \frac{A}{l_0} y = \\ = \tilde{m} \frac{d^2 F}{dt^2} + \tilde{c} \frac{dF}{dt} + \tilde{k} F - \tilde{k}^* F_Y \end{aligned} \quad (12)$$

where:

$$\begin{aligned}\frac{\tilde{m}}{\tilde{k}} &= \frac{T_K^{D^2}}{1 + \varphi_{vp}}, \quad \frac{m}{\tilde{k}} = \frac{E_H T_K^{D^2}}{1 + \varphi_{vp}} \\ \frac{\tilde{c}}{\tilde{k}} &= \frac{2 + \varphi_{vp}}{1 + \varphi_{vp}} T_K^D, \quad \frac{c}{\tilde{k}} = 2 \frac{E_H T_K^D}{1 + \varphi_{vp}} \\ \frac{k}{\tilde{k}} &= \frac{E_H}{1 + \varphi_{vp}}, \quad \frac{\tilde{k}^*}{\tilde{k}} = \frac{\varphi_{vp} - \varphi^*}{1 + \varphi_{vp}}\end{aligned}\quad (13)$$

A mechanical longitudinal wave propagates in an elastic solid metals at the finite velocity, $\sim 5000m/s$. Accordingly, the characteristic time T_K^D to be small number, so that the terms, which have multiplication by $(T_K^D)^2$ become negligible. For these oscillatory RDA systems the third order differential equation with respect to time t may be composed

$$\begin{aligned}\frac{2 + \varphi_{vp}}{1 + \varphi_{vp}} T_K^D M \frac{d^3 y}{dt^3} + M \frac{d^2 y}{dt^2} - \frac{\varphi_{vp} - \varphi^*}{1 + \varphi_{vp}} M \frac{d^2 y}{dt^2} + 2 \frac{T_K^D}{1 + \varphi_{vp}} k \frac{dy}{dt} + \frac{1}{1 + \varphi_{vp}} ky = \\ = \frac{2 + \varphi_{vp}}{1 + \varphi_{vp}} T_K^D \frac{dF}{dt} + F - \frac{\varphi_{vp} - \varphi^*}{1 + \varphi_{vp}} F_Y\end{aligned}\quad (14)$$

In the stage of visco-elasticity $\varphi_{vp} = \varphi^*$, the Eq. 14 takes the form of

$$\frac{2 + \varphi^*}{1 + \varphi^*} T_K^D M \frac{d^3 y}{dt^3} + M \frac{d^2 y}{dt^2} + 2 \frac{T_K^D}{1 + \varphi^*} k \frac{dy}{dt} + \frac{1}{1 + \varphi^*} ky = \frac{2 + \varphi^*}{1 + \varphi^*} T_K^D \frac{dF}{dt} + F \quad (15)$$

3. THE VISCO-ELASTIC RDA OSCILLATOR

Damping is basically a dissipation of energy, which occurs in the damper P. Metallic dampers mainly consisting of low carbon steel. Two equivalent expressions for the critical (minimal) damping of the bar defined as mass and/or stiffness proportional can be obtained using by the basic RDA equations see Milašinović [8]

$$c_{\min} = c_{cr} = m \left(\frac{E_K}{\lambda_K} + \frac{H'}{\lambda_N} \right) = 2m \frac{1}{T_K^D} \quad (16)$$

$$c_{\min} = c_{cr} = k \left(\frac{\lambda_K}{E_K} + \frac{\lambda_N}{H'} \right) = 2k T_K^D \quad (17)$$

Thus the minimal viscous damping ratio of the RDA model is

$$\xi_{\min} = 1 \quad (18)$$

Owing to the visco-elastic nature of the material of the damper, the measure of phase angle between the applied stress and subsequent strain is more importantly

$$\tan \alpha = \frac{\delta \cdot \varphi^*}{1 + \delta^2 + \varphi^*} \quad (19)$$

The representative computations of the previous equation are shown in Fig. 2. The curves on this figure have been computed for the values of creep coefficient: $\varphi^* = 0.5, 1, 2, 3, 4, 5,$ and 6 .

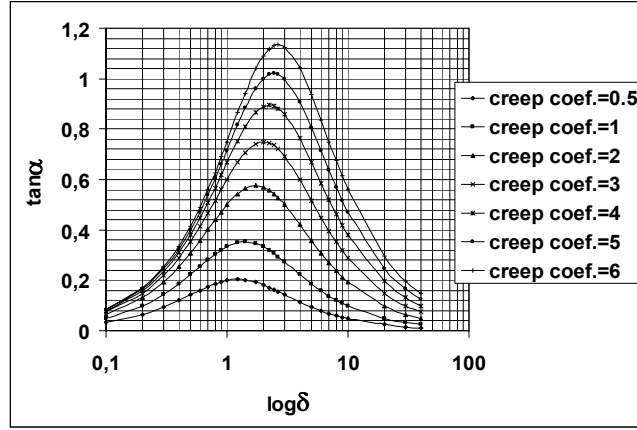

Fig. 2. Frequency dependence of the phase angle of the RDA model

The RDA model has the same natural frequency as a simple single-degree-of-freedom spring mass system and because of that we can form a new single RDA system with one lumped element of mass (Fig. 3), where natural and relative frequencies are:

$$\omega^* = \sqrt{\frac{k_{eq}}{m+M}} = \sqrt{\frac{k_{eq}}{m\left(1+\frac{M}{m}\right)}} = \omega \frac{1}{\sqrt{(1+\varphi^*)(1+\eta)}} \quad (20)$$

$$\delta^* = \frac{\omega_F}{\omega^*} = \frac{\omega_F}{\omega} \sqrt{(1+\varphi^*)(1+\eta)} = \delta \sqrt{(1+\varphi^*)(1+\eta)} \quad (21)$$

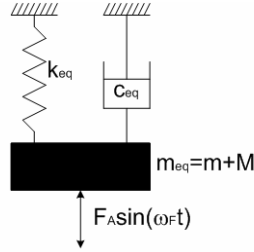

Fig. 3. – A new single RDA visco-elastic system with one lumped element of mass

k_{eq} is the permanent stiffness

$$k_{eq} = \frac{k}{1 + \varphi^*} \quad (22)$$

η is the mass ratio

$$\eta = \frac{M}{m} \gg 1 \quad (23)$$

m is mass of the damper.

δ is the relative frequency of the RDA model

$$\delta = \frac{\omega_\sigma}{\omega} = T_K^D \omega_F \quad (24)$$

where

$$\omega_\sigma = \omega_F \quad (25)$$

Also, the RDA model has the same phase angle as a simple single-degree-of-freedom spring mass system with damping in the linear steady state vibration and from that we can form equality, from which yields the viscous damping ratio of single RDA system with one lumped element of mass

$$\frac{\delta \varphi^*}{1 + \delta^2 + \varphi^*} = \frac{2\xi \delta^*}{1 - \delta^{*2}}, \Rightarrow \xi = \frac{\varphi^* \delta (1 - \delta^{*2})}{2\delta^* (1 + \delta^2 + \varphi^*)} \quad (26)$$

The viscous damping ratio, which is formulated using the principle of analogy, is a function of various relative parameters: φ^* , η and δ . It is known that for the base isolation, the fundamental frequency of the whole structure is dominated by the natural frequency of the base isolator. Consequently, it is very important to evaluate the viscous damping ratio for the isolator, which is the function of mentioned parameters.

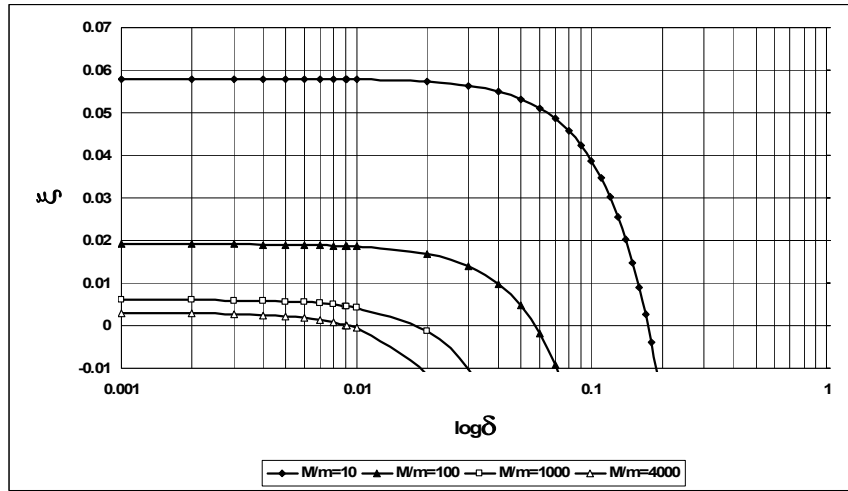

Fig. 4. Frequency (δ) dependence of the viscous damping ratio of single RDA system with one lumped element of mass for creep coefficient $\varphi^*=2$

The viscous damping ratio is shown in Fig. 4 for the creep coefficient $\varphi^* = 2$, where all values are positive. Owing to the frequency dependence of the viscous damping ratio ξ it is useful to consider separately the situations arising when the ξ is positive (system is stable) and when it is negative. Negative damping ratio means that the complementary solution of the response would not die away (the system is unstable because of the factor $e^{\xi\omega t}$).

However, it may be important to analyze the dependence of the viscous damping ratio on the relative frequency δ^* (Fig. 5), because this frequency is the function of mass ratio η .

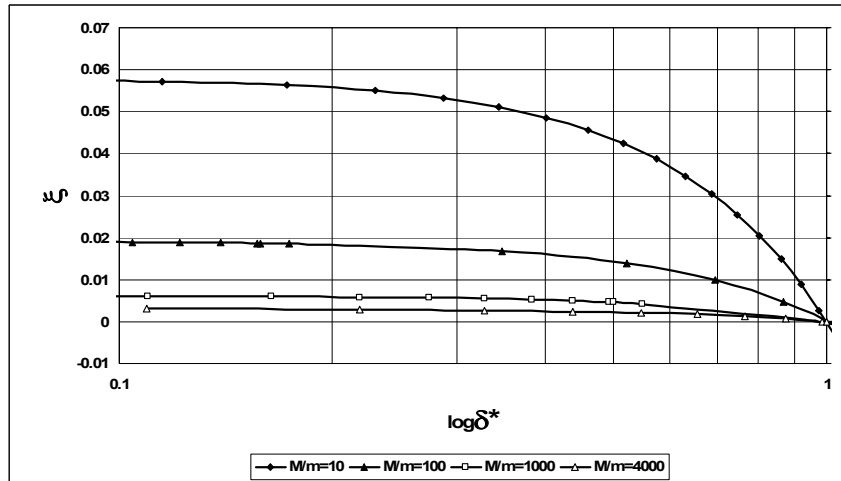

Fig. 5. Frequency (δ^*) dependence of the viscous damping ratio of single RDA system with one lumped element of mass for creep coefficient $\varphi^*=2$

The purpose of the energy dissipation devices is to increase the natural period of the structure so that the acceleration response of the structure is decreased during the gust. The effective period T_{eqd} for the RDA system can be written as

$$T_{eqd} = \frac{2\pi}{\omega_d^*} = \frac{2\pi}{\omega^* \sqrt{1-\xi^2}} = \frac{2\pi}{\omega} \sqrt{\frac{(1+\varphi^*)(1+\eta)}{1-\xi^2}} \quad (27)$$

or

$$T_{eq} = \frac{2\pi}{\omega^*} = \frac{2\pi}{\omega} \sqrt{(1+\varphi^*)(1+\mu)} \quad (28)$$

where T_{eq} is the natural period of the structure.

The effective period ratio can be represented as

$$\frac{T_{eqd}}{T} = \sqrt{\frac{(1+\varphi^*)(1+\eta)}{1-\xi^2}} \quad (29)$$

or

$$\frac{T_{eq}}{T} = \sqrt{(1+\varphi^*)(1+\eta)} \quad (30)$$

where T is the the period of the energy dissipation devices

$$T = \frac{2\pi}{\omega} = 2\pi T_k^D \quad (31)$$

The effective period ratios of the RDA system, shown in Fig. 6 are constants for all mass ratios while viscous damping ratios have positive values. However, the effective period ratio increases rapidly as the applied mass ratio increases.

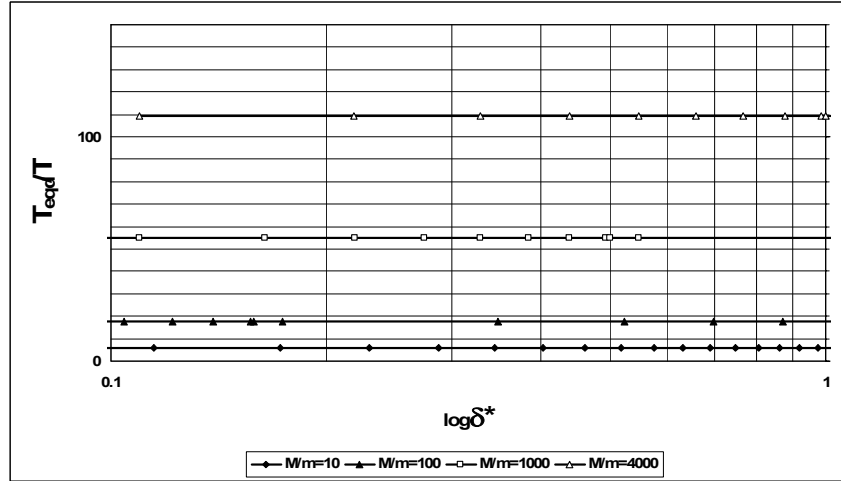

Fig. 6. Frequency (δ^*) dependence of the effective period ratio of single RDA system with one lumped element of mass for creep coefficient $\varphi^*=2$

This time considering also a new single RDA system with one lumped element of mass with effective stiffness $k_{eq}=k/(1+\varphi^*)$ and effective damping $c_{eq}=\xi\sqrt{2k_{eq}(m+M)}$, under the harmonic excitation $F(t)=F_A\sin(\omega_F t)$, we obtain the well known solution

$$y(t) = \sqrt{y_0^2 + \left(\frac{\dot{y}_0 + y_0 \xi \omega^*}{\omega_d^*}\right)^2} e^{-\xi \omega^* t} \cos\left(\omega_d^* t - \arctan\left(\frac{\dot{y}_0 + y_0 \xi \omega^*}{y_0 \omega_d^*}\right)\right) + \frac{F_A}{k_{eq}} \frac{1}{\sqrt{(1-\delta^{*2})^2 + (2\xi\delta^*)^2}} \sin\left(\omega_F t - \arctan\left(\frac{2\xi\delta^*}{1-\delta^{*2}}\right)\right) \quad (32)$$

where:

$$y_0 = \frac{F_A}{AE_H} l_0, \quad \dot{y}_0 = \frac{F_A}{A} \frac{\varphi^*}{E_H T_K} l_0$$

$$\xi = \frac{\varphi^* \delta (1 - \delta^{*2})}{2\delta^* (1 + \delta^2 + \varphi^*)}$$

$$\omega^* = \omega \frac{1}{\sqrt{(1 + \varphi^*)(1 + \eta)}}, \quad \omega_d^* = \omega^* \sqrt{1 - \xi^2} \quad (33)$$

$$\delta^* = \delta \sqrt{(1 + \varphi^*)(1 + \eta)}$$

$$k_{eq} = \frac{k}{1 + \varphi^*}, \quad c_{eq} = \frac{\varphi^* \delta (1 - \delta^{*2})}{\delta^* (1 + \delta^2 + \varphi^*)} \sqrt{\frac{k}{1 + \varphi^*}} (m + M)$$

The amplitude of the steady state response of the single RDA system with one lumped element of mass can be written in the form

$$A = \frac{F_A}{k_{eq}} \frac{1}{\sqrt{(1 - \delta^{*2})^2 + (2\xi\delta^*)^2}} \quad (34)$$

The static deflection F_A/k_{eq} is multiplied by the dynamic magnification factor

$$D = \frac{1}{\sqrt{(1 - \delta^{*2})^2 + (2\xi\delta^*)^2}} \quad (35)$$

4. THE VERIFICATION OF RESULTS OF VISCO-ELASTIC RDA OSCILLATOR ON LOW CARBON STEEL BAR

Extensive work in the several years has been done on analogy; see Milašinović [6] and [7]. The test material was low carbon steel. The low carbon steels are an economic yet effective solution for the seismic retrofit of highway bridges. These readily available materials have a yielding stress of 32 *ksi* (220.64 *Mpa*).

The proportional stress ($\sigma_p = 142MPa$) or reaction-stress of the clamped bar under axially fatigue process is obtained using physical characteristics of low carbon steel only, like: specific heat, coefficient of linear thermal expansion and mass density. Elasticity stress ($\sigma_E = 187MPa$) of the bar under compression is obtained as Euler's critical stress from which we have that elasticity stress also becomes dependent upon the dimensions of the bar (its length and diameter) and thus is no more a physical characteristics of the material only. In ductile materials like metals, some difference between the point of proportionality and the point of elasticity produce the deviation from perfect elasticity with dissipation of mechanical energy through quasi-viscous flow or visco-elastic creep. This is the reason of the drop in the stress-strain curve in the average σ - ε diagram with upper and lower-yield points, see Milašinović [7].

In order to clarify the influence the relative ratios: $\eta = M/m$, φ^* and $\delta = T_K^D \omega_F$ ($\omega_F = 2\pi f_F$) on the viscous damping ratio and the dynamic magnification factor, the steel bar was analyzed under four values of η (10, 100, 1000, 3683), $\varphi^* = 2$ and excitation frequency, $f_F = 15Hz$ ($\delta = 0.009114$). Table 1 gives values of viscous damping ratios and dynamic magnification factors, calculated from Eqs. (26) and (35) for relative frequencies varying from $\delta = 0.001$ to $\delta = 100$ and for the maximal mass ratio, $\eta = 3683$.

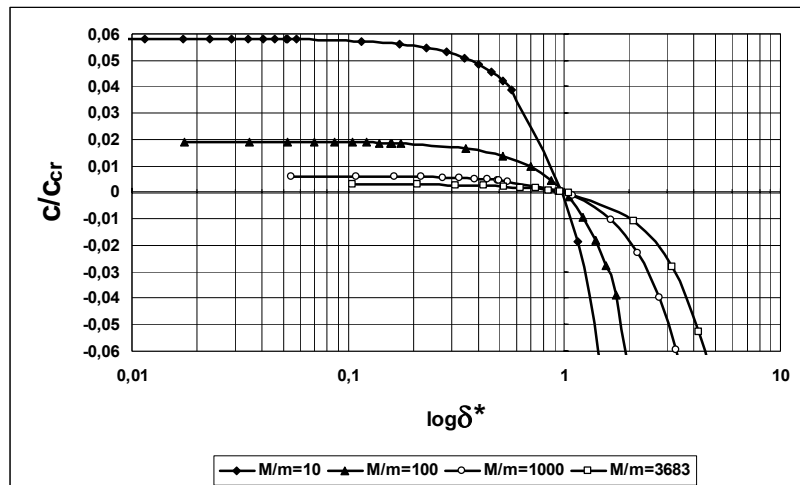

Fig. 7. The dependence of the viscous damping ratio on relative frequencies δ^*

Figure 7 gives variations of the viscous damping ratio on the relative frequency δ^* for four values of η (10, 100, 1000, 3683). It can be seen from Fig. 7 that if the mass ratio is smaller, the viscous damping ratio will be larger and also that if the relative frequency is larger, the viscous damping ratio will be smaller. It is interesting to note that for $\eta = 1000$, positive viscous damping ratio decreasing from 0.006 to 0.004. This confirms similar experimental observations made on steel, which show $0.01 > c / c_{cr} > 0.003$.

Table 1. Values of viscous damping ratios and dynamic magnification factors

$\delta = T_K^D \omega_F$ Prototype $T_K^D = 0.0000967s$ $f_F = 15Hz$ $\omega_F = 2\pi f_F = 94.25rad/s$ $\delta = 0.009114$	$\delta^* = \delta \sqrt{(1+\varphi^*)(1+\eta)}$ Prototype $\sigma_P = 142Mpa$ $F_A = (19^2 \pi / 4) 142 = 40261N$ $M = F_A / g = 4104kg$ $\eta = M/m = 4104 / 1.114 = 3683$ $\delta^* = 0.958141$	ξ	D
0,001	0,105128	0,003136	1,011175
0,002	0,210257	0,003031	1,046252
0,003	0,315385	0,002855	1,110452
0,004	0,420514	0,00261	1,214815
0,005	0,525642	0,002295	1,38178
0,006	0,630771	0,001909	1,660763
0,007	0,735899	0,001454	2,18123
0,008	0,841028	0,000928	3,416746
0,009	0,946156	0,000332	9,542906
0,00914	0,958141	0,00026	12,20001
0,01	1,051285	-0,00033	9,505492
0,02	2,10257	-0,01084	0,292303
0,03	3,153855	-0,02836	0,111749
0,04	4,20514	-0,05287	0,059919
0,05	5,256425	-0,08437	0,037531
0,06	6,30771	-0,12284	0,025761
0,07	7,358994	-0,16826	0,018793
0,08	8,410279	-0,22063	0,01432
0,09	9,461564	-0,27992	0,011277
0,1	10,51285	-0,3461	0,009111
0,2	21,0257	-1,38014	0,002248
0,3	31,53855	-3,05892	0,000988
0,4	42,0514	-5,31995	0,000549
0,5	52,56425	-8,08388	0,000346
0,6	63,0771	-11,2609	0,000237
0,7	73,58994	-14,7574	0,000171
0,8	84,10279	-18,4815	0,000129
0,9	94,61564	-22,3477	0,000101
1	105,1285	-26,2797	8,09E-05
2	210,257	-60,0721	1,96E-05
3	315,3855	-78,8456	8,99E-06
4	420,514	-88,5288	5,21E-06
5	525,6425	-93,8644	3,41E-06
6	630,771	-97,0414	2,4E-06
7	735,8994	-99,0632	1,78E-06
8	841,0279	-100,421	1,38E-06
9	946,1564	-101,374	1,09E-06
10	1051,285	-102,066	8,88E-07
20	2102,57	-104,346	2,25E-07
30	3153,855	-104,779	1E-07
40	4205,14	-104,932	5,65E-08
50	5256,425	-105,002	3,62E-08
60	6307,71	-105,041	2,51E-08
70	7358,994	-105,064	1,85E-08
80	8410,279	-105,079	1,41E-08
90	9461,564	-105,09	1,12E-08
100	10512,85	-105,097	9,05E-09

The dynamic magnification factors for the above four mass ratios are shown in Fig. 8. It is seen that all dynamic magnification factors increase with respect to relative frequencies $0.001 < \delta^* \leq 1$. Note, however, that all factors decreasing for negative values of ξ ($\delta^* \geq 1$). The negative values of ξ are examined only as a hypothetical case because the complementary solution of the response associated with negative viscous damping ratio would not die away. The system is unstable because of the factor $e^{\xi \cdot \omega \cdot t}$.

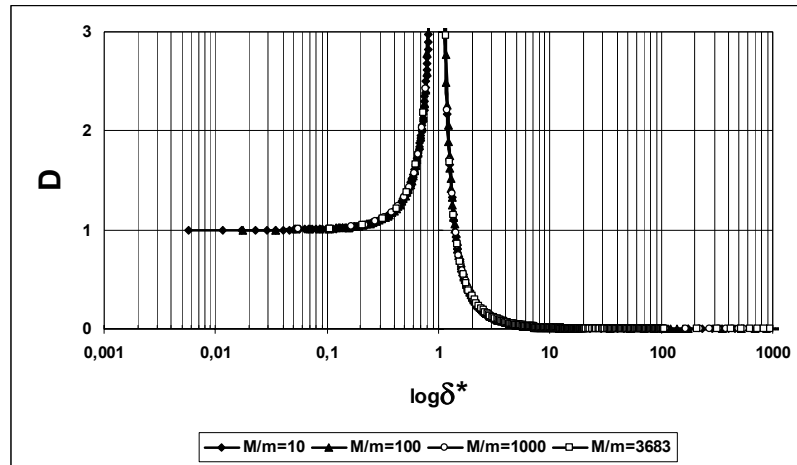

Fig. 8. The dependence of the dynamic magnification factor on relative frequencies δ^*

The corresponding value for maximal mass ratio $\eta = 3683$ was $D = 12.20$, while for $\eta = 1000$ it is found that $D = 37.00$. Note however that the dynamic magnification factor has maximal value of $D = 1113.76$ for $\eta = 10$. In this case the relative frequency $\delta^* = 0.999554$ is very close to one, which is the case of resonance. Resonance occurs when the frequency of the excitation ω_F is equal to the natural frequency of the RDA system

$$\omega^* = \frac{\omega}{\sqrt{(1 + \phi^*)(1 + \eta)}}$$

Finally it is useful to analyze the dependences of the viscous damping ratio (Fig. 9) and the dynamic magnification factor (Fig. 10) on the relative frequency δ of the RDA model, because this frequency is independent of mass ratio η .

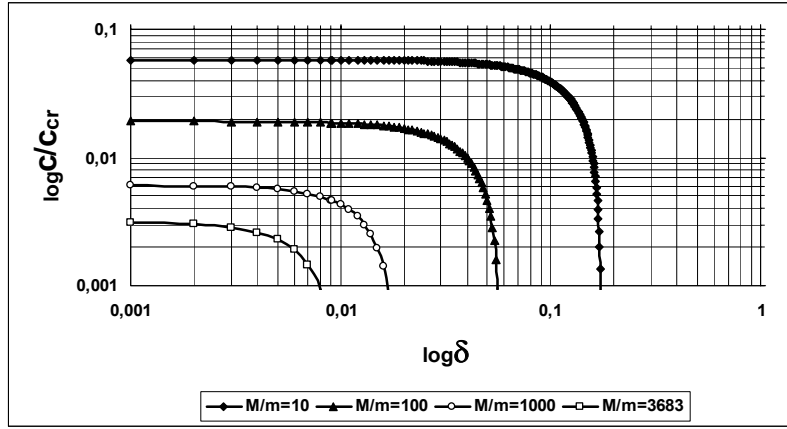

Fig. 9. The dependence of the viscous damping ratio on relative frequencies δ^*

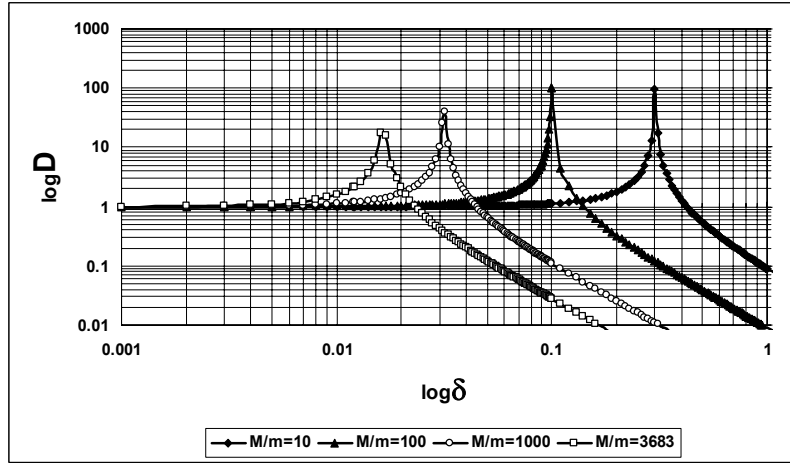

Fig. 10. The dependence of the dynamic magnification factor on relative frequencies δ

The exemplary calculations for one degree of freedom visco-elastic RDA system are performed based on the formulas derived in the former chapter. Calculations are done for the harmonic excitation

$$F(t) = F_0 + F_A \sin(\omega_F t)$$

where $F_0 = \sigma_0 A$, ($\sigma_0 = E_H \epsilon_0$)

Solution under constant permanent force F_0 has the form of

$$y(t) = \sqrt{y_0^2 + \left(\frac{\dot{y}_0 + y_0 \xi \omega^*}{\omega_d^*} \right)^2} e^{-\xi \omega^* t} \cos \left(\omega_d \cdot t - \arctan \left(\frac{\dot{y}_0 + y_0 \xi \omega^*}{y_0 \omega_d^*} \right) \right) + \frac{F_0}{k_{eq}}$$

The first part of the solution, the complementary, usually called the transient, will eventually die out. Also, the rate of decay and natural frequency of the system depend on the system parameters only, while the amplitude of vibration and phase angle are determined by the initial conditions.

Some values of parameters of a single RDA system with one lumped element of mass of steel bar appear in Table 1. the results of other parameters that must be used for computational results of longitudinal vibration are presented in Table 2. The bar is loaded with cyclic sinusoidal load in symmetrical cycle and frequency $f = 15\text{Hz}$ ($\omega_F = 2\pi f = 94.25\text{rad/s}$).

Table 2. The RDA model and single RDA system parameters

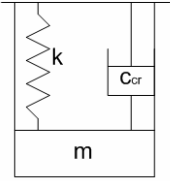
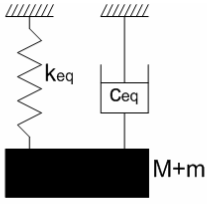
$\Phi=19\text{mm}$ $l_0=500\text{mm}$ $\sigma_0=142\text{MPa}$ $F_0=(19^2\pi/4)\times 142$ $=40261\text{N}$ $k=E_H A/l_0=119.08$ MN/m $m=\rho A l_0=1.114\text{kg}$ $M=F_0/g=4104\text{kg}$ $\omega_F=2\pi f=2\pi 15=$ $=94.25\text{rad/s}$	 RDA model		 Single RDA system	
	Characteristic time	$T_K^D=l_0/\sqrt{E_H/\rho}$ [s]	0.0000967	
Creep coefficient	φ	2.00		
Initial strain (displacement)	$\varepsilon_0=\sigma_0/E_H$	0.000676	$y_0=\varepsilon_0 l_0=F_0/k$ [m]	0.000338
Initial strain rate (velocity)	$d\varepsilon_0/dt=\sigma_0/\lambda_k=$ $=\varepsilon_0\varphi^*/T_K^D$ [1/s]	13.98	$dy_0/dt=(d\varepsilon_0/dt)l_0$ [m/s]	6.99
Mass ratio			$\eta=M/m$	3683
Angular frequency	$\omega=1/T_K^D$ [1/s]	10341	$\omega^*=\omega/\sqrt{(1+\varphi^*)(1+\eta)}$ [rad/s]	98.365
Relative frequency	$\delta=\omega_F T_K^D$	0.009114	$\delta^*=\omega_F/\omega^*$	0.958141
Viscous damping ratio	ξ	1.00	ξ	0.00026
Damped frequency			$\omega_d^*=\omega^*\sqrt{1-\xi^2}$	98.365

The solution with parameters from Table 2 takes the form of

$$\sqrt{y_0^2 + \left(\frac{\dot{y}_0 + y_0 \xi \omega^*}{\omega_d^*} \right)^2} =$$

$$\sqrt{0.000338^2 + \left(\frac{6.99 + 0.000338 \cdot 0.00026 \cdot 98.365}{98.365} \right)^2} = 0.071\text{m}$$

$$e^{-\xi \omega^* t} = e^{-0.00026 \cdot 98.365 t} = e^{-0.025575 t}$$

$$\arctan \left(\frac{\dot{y}_0 + y_0 \xi \omega^*}{y_0 \omega_d^*} \right) = \arctan \left(\frac{6.99 + 0.000338 \cdot 0.00026 \cdot 98.365}{0.000338 \cdot 98.365} \right) = 1.566\text{rad}$$

$$\frac{F_0}{k} (1 + \varphi^*) = \frac{40261}{119.08 \cdot 10^6} (1 + 2) = 0.000338 \cdot 3 = 0.001\text{m}$$

$$y(t) = 0.071 \cdot e^{-0.025575 t} \cos(98.365 \cdot t - 1.566) + 0.001$$

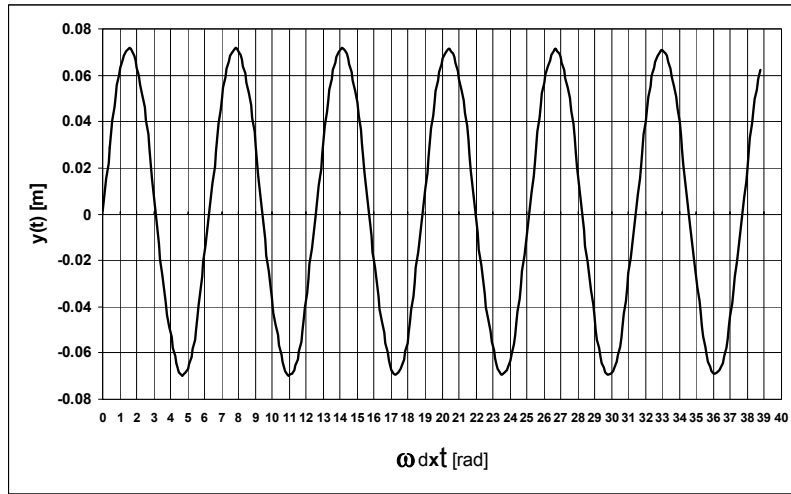

Fig. 11. The transient vibration amplitudes with permanent force F_0 ($0 < t < 0.4s$)

Figure 11 ($0 < t < 0.4s$) and Fig. 12 ($80 < t < 1000s$) display the transient vibration amplitudes. From the beginning (Fig. 11), the RDA oscillator moves periodically and then alight to a constant regime (Fig. 12). The complementary solution die out after 300s ($98.365 \cdot 300 = 29510rad$).

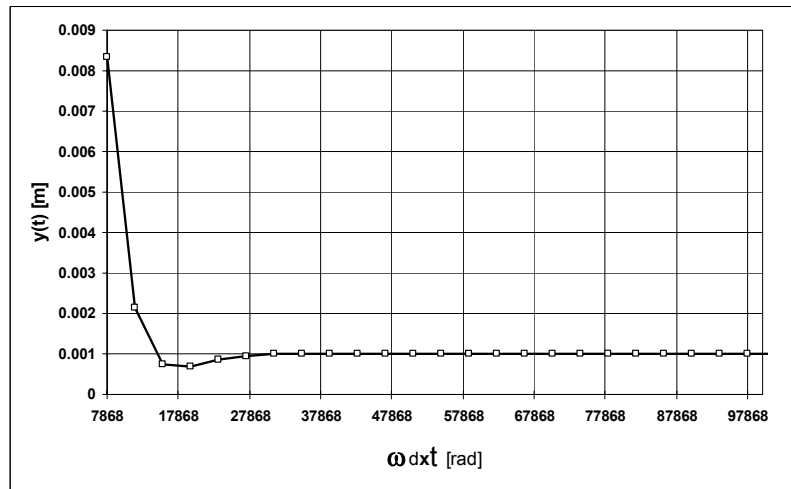

Fig. 12. The transient vibration amplitudes with permanent force F_0 ($80 < t < 1000s$)

Let us consider the periodically force $F(t)$ ($F_A = (19^2 \pi / 4) \times 142 = 40261N$), which is applied slowly

$$F(t) = F_A \sin(\omega_F t)$$

where $f = 15Hz$ ($\omega_F = 2\pi f = 94.25rad/s$).

The solution of the RDA oscillator has the form of

$$y(t) = \frac{F_A}{k_{eq}} \frac{1}{\sqrt{(1-\delta^{*2})^2 + (2\xi\delta^*)^2}} \sin\left(\omega_F \cdot t - \arctan\left(\frac{2\xi\delta^*}{1-\delta^{*2}}\right)\right)$$

where

$$\frac{F_A}{k} \frac{(1+\varphi^*)}{\sqrt{(1-\delta^{*2})^2 + (2\xi\delta^*)^2}} = \frac{0.000338 \cdot 3}{\sqrt{(1-0.958141^2)^2 + (2 \cdot 0.00026 \cdot 0.958141)^2}} = 0.0041 \cdot 3 = 0.01237m$$

$$\arctan\left(\frac{2\xi\delta^*}{1-\delta^{*2}}\right) = \arctan\left(\frac{2 \cdot 0.00026 \cdot 0.958141}{1-0.958141^2}\right) = 0.00608rad$$

Finally, the solution is

$$y(t) = 0.01237 \cdot \sin(94.24778 \cdot t - 0.00608)$$

Figure 13 display the steady vibration amplitudes, which are found for three types of vibrations: the RDA visco-elastic, the RDA oscillator (elastic solution) and the RDA oscillator (visco-elastic solution). The RDA visco-elastic results are obtained by solving Eq. 6.

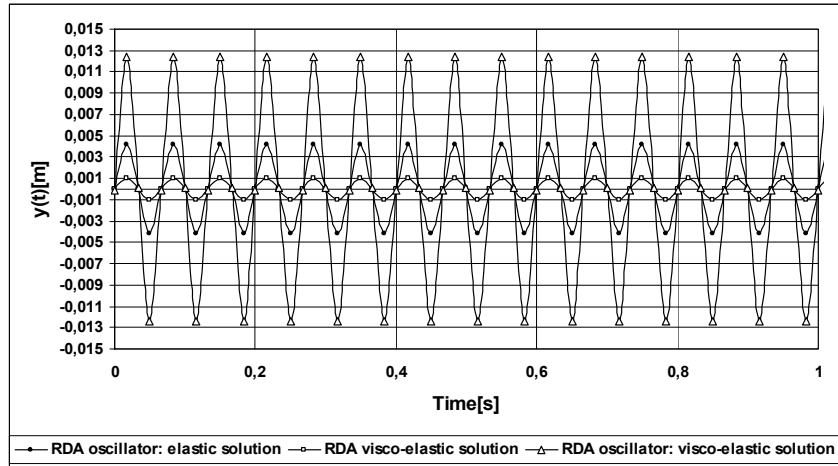

Fig. 13. Steady state response of forced longitudinal vibration of prototype

The elastic solution according to the RDA oscillator has the maximal amplitude of $0.00412m$, which is greater for 12.2 ($0.00412/0.000338=12.2$) from maximal amplitude under constant force F_0 . It is in accordance with dynamic magnification factor D (see Fig. 10, $M/m = 3683$).

The RDA oscillator give the visco-elastic maximal amplitude of $0.01237m$, which is greater for 12.2 ($0.01237/0.001014=12.2$) from maximal amplitude obtained using the RDA visco-elastic model (see Eq. 6).

5. VISCO-ELASTO-PLASTIC RDA OSCILLATOR

The only difference to be noted for a bar that is elastically deformed and one that is inelastically deformed is the stress-strain relation for the material of the bar. Inelasticity theory would be greatly simplified if one function could be found to approximate the stress-strain diagram over both the elastic and inelastic range. This function may be obtained as isochronous octahedral shearing stress-octahedral shearing strain RDA diagram (see [7], Section 8). Since about 1997 (Milašinović [4]), mathematical-physical analogy between the visco-elasto-plastic rheological model and the dynamical model was proposed to an explicit form to predicting many different inelastic and time dependent problems related to prismatic bars, such as buckling, fatigue etc.

According to the principle of analogy, the visco-elasto-plastic oscillator has the same solution as the visco-elastic one (see Chapter 3), if we chose

$$\varphi_{vp} = \varphi^*(1+i), i = 0, 1, 2, \dots \quad (36)$$

where i is the level for visco-plastic yielding at any stage of dynamic equilibrium.

Also, the forces: F_{max} , F_A and F_Y are not independent. The following expressions may be derived, for the known: F_P , F_E , F_0 and φ^* (see [7], Section 5.2)

$$F_{max}^{(i)} = \frac{F_P(1+i\varphi^*) + F_E(1+\varphi^*)[i(1+i\varphi^*)-1]}{i\varphi^*(1+i\varphi^*)}, \quad F_Y = \frac{F_P}{\varphi^*} + F_E,$$

$$r^{(i)} = \frac{2F_0 - F_{max}^{(i)}}{F_{max}^{(i)}}, \quad F_A^{(i)} = \frac{1-r^{(i)}}{2} F_{max}^{(i)}. \quad (37)$$

In this way the RDA oscillator has the advantage that all the calculations of the strain-to-stress type (which is the way usually needed in computer calculation) may be carried out explicitly, i.e., without the need for any step-by-step or iterative integration procedure in the loading steps.

6. CONCLUSION

In this paper the rheological-dynamical theory of the analytical dynamics of discrete visco-elasto-plastic system is presented. The coupled initial conditions of the stress-strain state of the rheological visco-elasto-plastic model are applied for the study of single RDA system. The motion of the RDA system is described by the equation with the highest derivative of the fourth order with respect to time t .

In the case of linear visco-elasticity, RDA model has the same natural frequency as a simple single-degree-of-freedom spring mass system and because of that a new single RDA system with one lumped element of mass is formed. Also, the RDA model has the same phase angle as a simple single-degree-of-freedom spring mass system with damping in the linear steady state vibration and from that the viscous damping ratio of the RDA system is obtained. The viscous damping ratio is a function of various relative parameters of the RDA model like: creep coefficient φ^* , mass ratio η and relative frequency δ . It is known that for the base isolation, the fundamental frequency of the whole structure is dominated by the natural frequency of the base isolator. Consequently, it is very important to evaluate the viscous damping ratio for the isolator, which is the function of

mentioned relative parameters. The purpose of the energy dissipation devices is to increase the natural period of the structure so that the acceleration response of the structure is decreased during the gust. The effective period ratio increases rapidly as the applied mass ratio increases.

The visco-elastic RDA oscillator is confirmed and validated by some of the published experimental data on the monotonic and the cyclic loading of mild-steel.

While studying the discrete visco-elasto-plastic RDA system in Chapter 2, the fourth order differential equation with the small parameter before the highest derivative is given as a basic result. For such equations, as known according to A. I. Tykhonov theorems, the solution of singular equation does not always converge to initial. So we cannot approve that the third order differential equation describes the initial system correctly. Nevertheless, visco-elasto-plastic RDA oscillator has been generated from mathematical-physics analogy, through an elegant framework that bypasses most of the questions arising from the vibration of visco-elasto-plastic bodies.

Acknowledgement: *This work was supported by the "Ministry of Science and Environmental Protection - Republic of Serbia", Project: 144037.*

REFERENCES

1. Clough, R. W. and Penzien, J., *Dynamics of Structures*, McGraw-Hill, New York, 1975
2. Goroshko, O. A. and Hedrih (Stevanović), K., *Analytical Dynamics of Discrete Hereditary Systems*, University of Niš, Kiew-Niš (in Serbian), 1999-2000-2001.
3. Love, A. E. H., *A Treatise on the Mathematical Theory of Elasticity*, 4th Ed., Dover Publications, New York, 1944.
4. Milašinović, D. D., *The Finite Strip Method in Computational Mechanics*, Faculties of Civil Engineering: Subotica, Budapest, Belgrade, 1997.
5. Milašinović, D. D., Rheological-dynamical analogy: prediction of buckling curves of columns, *International Journal of Solids and Structures* 37(29) pp. 3965-4004, 2000.
6. Milašinović, D. D., Rheological-dynamical analogy: modeling of fatigue behavior, *International Journal of Solids and Structures* 40(1) pp. 181-217, 2003.
7. Milašinović, D. D., Rheological-dynamical analogy: visco-elasto-plastic behavior of metallic bars, *International Journal of Solids and Structures* 41(16-17) pp. 4599-4634, 2004.
8. Milašinović, D. D., Rheological-dynamical Analogy: Frequency Dependence of the System Parameters of Internally Damped Bars, *Multidiscipline Modeling in Materials and Structures* 1(2) pp. 143-170, 2005.
9. Milašinović, D. D., Rheological-Dynamical Theory of Visco-Elasto-Plasticity and Fatigue: Part 1, *Multidiscipline Modeling in Materials and Structures* 2(1) pp. 1-29, 2006.
10. Reiner, M., *Rheologie the'orique*, Dunod, Paris, France, 1955.

REOLOŠKO-DINAMIČKI HARMONIJSKI OSCILATOR

Dragan D. Milašinović

U radu je predstavljena reološko-dinamička teorija analitičke dinamike diskretnih visko-elasto-plastičnih sistema. Reološko-dinamička analogija (RDA) je razvijena na bazi matematičko-fizičke analogije između reološkog modela i diskretnog dinamičkog modela sa viskoznim prigušenjem sa ciljem da bude korištena u analizi neelastičnog deformisanja materijala i konstrukcija. U ovoj prezentaciji, povezani početni uslovi naponsko-deformacijskog stanja reološkog visko-elasto-plastičnog modela su primjenjeni u studiji diskretnog dinamičkog sistema. Mehanički sistemi kao što su kablovi, štapovi, grede, ploče i drugi, čije su mase i elastične sile raspoređeni različito od

oprugama spojenih koncentrisanih masa, spadaju u grupu vibracija kontinualnih sistema. Ovi sistemi imaju beskonačno veliki broj djelića i zahtjevaju beskonačno veliki broj koordinata za specificiranje njihove konfiguracije. Ovaj tekst daje primjer i ilustruje način kako diskretan model može biti izveden, korištenjem principa analogije, iz specifičnih granica kontinualnog modela. Ova tehnika je korisna jer diskretan model u konceptualnom i proračunskom smislu često je mnogo jednostavniji za analizu od kontinualnog modela.

Ključne reči: *RDA analogija, RDA harmonijski oscilator, viskozno relativno prigušenje*